



CUPA PIZARRAS

The world leader in natural slate

ROOFING DESIGN AND FIXING GUIDE

CUPA PIZARRAS

The world leader in natural slate

CUPA PIZARRAS **leads the world in slate production.** Our 16 quarries and 22 processing plants combine the latest technology with our traditional know-how and craftsmanship.

Using cutting-edge production and quality controls, CUPA PIZARRAS produces unique, globally recognized natural slates that meet or exceed all international standards.

“Our strong commitment to **quality**, constant **innovation** and **sustainability** makes us world leaders in natural slate.”

The company owes its market leadership to the unsurpassed quality of its slates and the company's dedication to outstanding quality control and customer service. CUPA PIZARRAS takes quality control and testing very seriously and has rigorous systems in place to ensure that each slate meets or exceeds internationally recognised standards of excellence. The company's unique barcode

technology lists the quality, composition and source of each slate, from quarry to installation, enabling unequalled traceability and future matching. Slate is a timeless classic, which makes CUPA PIZARRAS a suitable choice for new build, residential and commercial projects. It is also regularly specified throughout the UK for projects within conservation areas, national parks, heritage sites and areas of outstanding

natural beauty as an acceptable replacement to indigenous slate as it has a very similar composition and is of comparable quality. CUPA PIZARRAS is part of CUPA GROUP, 64 companies that create innovative solutions with natural materials.

DESIGN

The installation of a slate roof involves a number of aspects that must be considered in the design process. Most significant is the environment, with the two main factors being exposure to wind and rain. The primary aspects to be considered are:

SITE EXPOSURE

Buildings positioned on slopes, hills or coastal areas as well as tall buildings will be graded with higher exposure.

TYPE OF SLATE

Small slates are more suitable for steep roofs, while the more exposed the site and on lower roof pitches, wider slates should be used and the lap increased. (See table)

SLATE LAP

This is established by measuring the roof pitch and considering the rain and wind exposure. Where the thickness of natural slates reduces their pitch by 3° or more, the next lower rafter pitch should be selected to determine the recommended head-lap.

MINIMUM HEADLAP FOR FIXING SLATES WITH NAILS OR HOOKS

Sheltered/Moderate exposure (less than 56.5l/m²)

Size (mm)	Rafter Pitch									
	20°	22.5°	25°	27.5°	30°	35°	40°	45° to 75°	85°	
600x300	-	-	95	85	80	70	60	55	50	
500x300	115	105	95	85	80	70	60	55	50	
500x250	-	-	95	85	80	70	60	55	50	
450x250	-	-	-	-	80	70	60	55	50	
400x250	-	-	-	-	80	70	60	55	50	
400x200	-	-	-	-	80	70	60	55	50	
350x250	-	-	-	-	80	70	60	55	50	
350x200	-	-	-	-	80	70	60	55	50	
300x200	-	-	-	-	80	70	60	55	50	

Please note that hook fixings should not be used on any pitch below 25°.

Severe/Very severe (56.5l/m² or greater spell)

Size (mm)	Rafter Pitch									
	20°	22.5°	25°	27.5°	30°	35°	40°	45° to 75°	85°	
600x300	-	-	120	110	100	85	80	70	65	
500x300	-	130	120	110	100	85	80	70	65	
500x250	-	-	-	110	100	85	80	70	65	
450x250	-	-	-	-	100	85	80	70	65	
400x250	-	-	-	-	100	85	80	70	65	
400x200	-	-	-	-	100	85	80	70	65	
350x250	-	-	-	-	100	85	80	70	65	
350x200	-	-	-	-	100	85	80	70	65	
300x200	-	-	-	-	100	85	80	70	65	

Please note that hook fixings should not be used on any pitch below 25°.

PITCH OF ROOF

When considering the minimum pitch for a slated roof it is necessary to establish the exposure of the site, the length of rafter and the height of the building. The recommendations shown above are based on a maximum height to eave of 12m and a maximum rafter length of 9m in moderate exposure and 6m in severe exposure.

RIBA APPROVED SEMINARS



CUPA PIZARRAS provide architects and designers free CPD seminars on slate roofing, flooring and cladding. If you would like to find out more please contact +44 (0) 131 22 53111.

GEOGRAPHIC CATEGORIES OF DRIVEN RAIN EXPOSURE AROUND THE UK

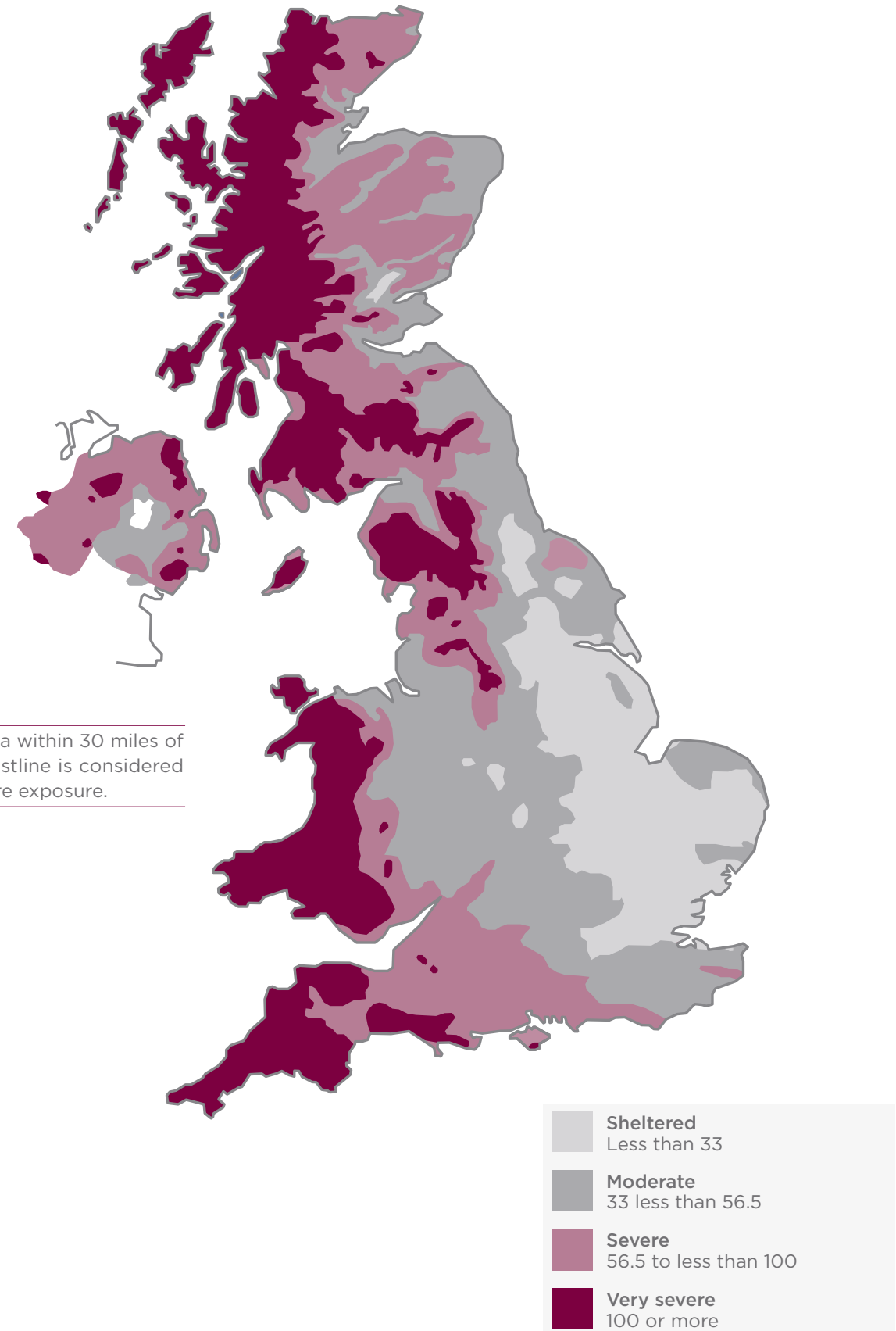

SITWORK

Slates are supplied in pallets and stacked on their long side. Once removed from their pallets, slates need to be graded and sorted into three or four thicknesses. If stacked on site they should be laid on the long side with battens between the layers.

During grading it is important to tap each slate to confirm its soundness. Once slates have been graded and checked for imperfections, fixing can begin. There are two methods of fixing natural roofing slates – nailing and hook fixing.

FIXING WITH NAILS

Slates can be supplied preholed. However, if on-site holing is undertaken, the following methods should be used.

HOLING (CENTRE FIXING)

Hole from the bed of the slate (its reverse), this allows the nail head to be located in the recess on the face of the slate, which is created by the holing process. Each slate should be holed twice.

The head of the slate should lay approximately halfway on to the batten (i.e. 25mm on to the batten) leaving 25mm to nail into. A clearance of 6–12mm is recommended.

Holes should be located between 20–25mm from the long edge of the slate. The underlay is then fixed and the roof marked to the batten gauge. This may require adjusting in order to create equal course numbers. The required lap should only ever be increased not decreased.

HOLING (HEAD FIXING)

Head or shoulder fixing is only acceptable for small or heavy slates. This practice is more common in Scotland. In Scottish practice it is common to nail slates to softwood sarking boards using a combination of shoulder-nailing and centrenailing to resist wind uplift. If this method is adopted it is recommended that every third course is nailed twice.

HOLING BY HAND

Wherever possible, machine holing is preferable. Holing by hand should only be considered when a small amount of slates need re-holing for repairs or when a hole needs to be repositioned in-situ. To hole a slate with a spike hammer, position the slate flatly over a narrow iron. When measuring the position of the holes ensure the thinner end of the slate is at the top when fixed. Holing should always be from the bed of the slate (its reverse) and each slate should be holed twice.



HOLING BY MACHINE

If slates are machine holed it is recommended that only one slate be holed at a time. If the machine uses a punching method then attention should be paid to the risk of damage. The holing machine will need to be well maintained and adjusted regularly. For this reason a boring method is preferable.

Prior to slating the roof the slates are stacked as follows: -

Eaves:	Thick slates
Middle Roof:	Medium slates
Ridge:	Thin slates

Nails are required to be 20-25mm longer than two thicknesses of slate. Nail head diameter should be at least 10mm. At the eaves course it is best to use nails that are longer, especially if there is also a sprocket.

Gauge for nailing

$$\text{Gauge} = \frac{(\text{length of slate} - \text{lap})}{2}$$

Gauge for hook fixing

$$\text{Gauge} = \frac{(\text{length of slate} + 10\text{mm}) - \text{hook length}}{2}$$

Ensure nails are not long enough to puncture membrane/felt.

FIXING WITH HOOKS

An alternative method of fixing slates is the use of slate hooks; however, hooks should not be used below a 25° roof pitch. In addition below a 30° degree pitch the hooks should have crimped shanks to reduce the capillary rise of water at the perpendicular joints between slates.

The use of hooks on roofs with a pitch above 75° requires special conditions.

When fixing slates with hooks all perimeter slates should be hook fixed and nailed.

HIPS AND VALLEYS

At hips or valleys it is important to ensure that the width of the cut slate is sufficient to allow adequate fixing. Where necessary slate and a half should be used.

VERGES AND ABUTMENTS

Alternate courses begin with a slate and a half, with the exception of those over 145mm, in which case only a slate is required. Slate and a half should be used in alternate courses.

Slate Nails

Nails should be either aluminium alloy or copper, silicone bronze or stainless steel in coastal areas.

Slate Hooks

Stainless steel slate hooks should be formed from stainless steel wire.



BATTENING AND UNDERLAYS

+ The maximum centres for rafters or trusses on new build is 600mm. Some older structures might have rafter centres of 400mm. The minimum size of a batten for slating is 25x50mm.

+ It is recommended that, once battens are fixed, every second perpendicular line is marked for slate joints. Slates should be laid with the thicker end as the tail, and correspond in thickness in each course. The thickest slates are fixed in the lowest courses and the thinnest toward the ridge. The slates are then fixed to the perpendicular lines, aligning the slate tails. A gap of 3-5mm between each slate is recommended.

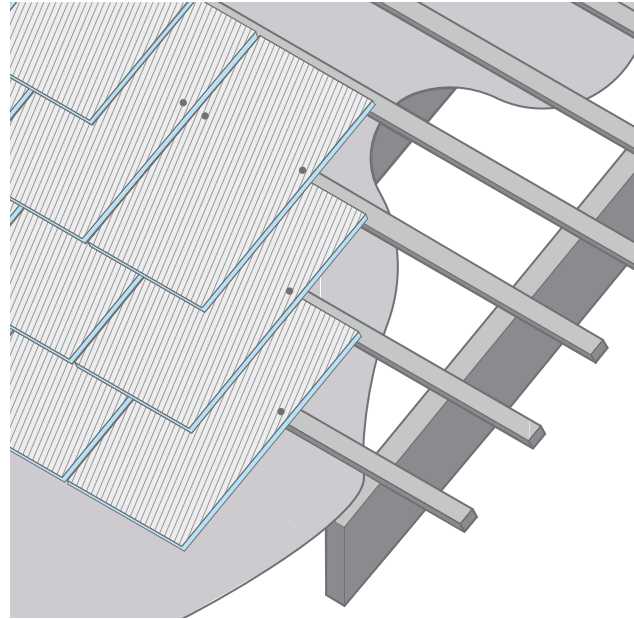

Open Rafter Construction



BOARDED ROOF CONSTRUCTION

+ Tongue and groove or square edge boarding, woodwool slabs or bitumen-impregnated sarking board. Underlay laid directly on to boards should be of bitumen felt or vapour permeable.

+ Where vapour permeable underlays are not used, boarded roofs should be counter battened. The counter batten should be of sufficient dimensions to provide a ventilation gap and/or to provide a drainage path beneath the battens.

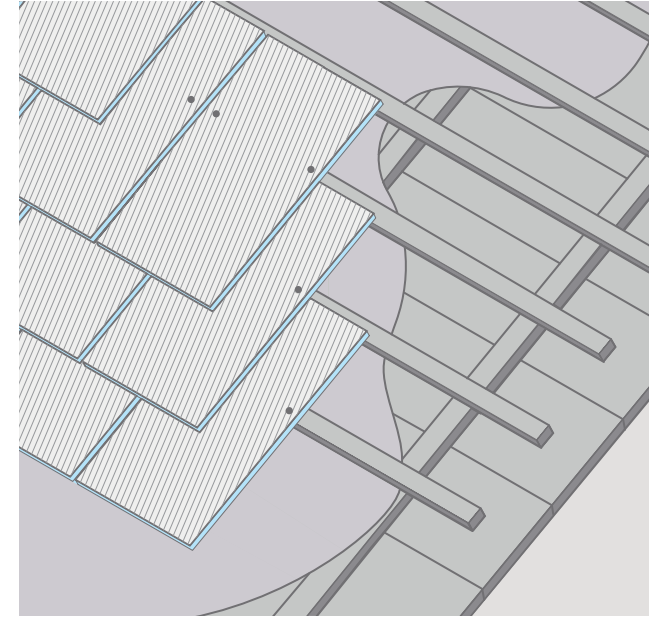



VENTILATION

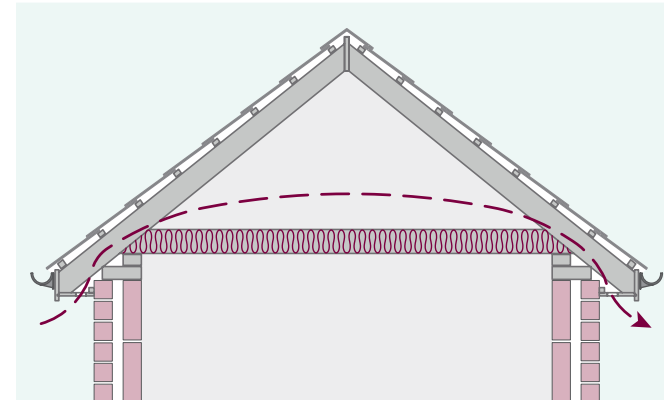

Cold roof insulation at ceiling joist level

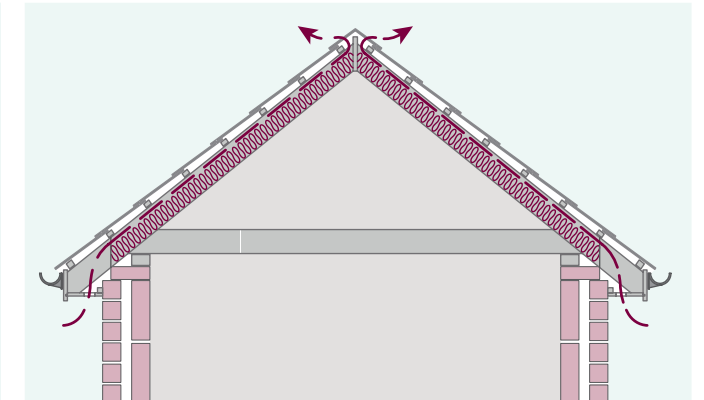

Warm roof insulation at rafter level

+ Roof space ventilation is the most effective and economic method of keeping harmful condensation to a minimum, and can be achieved by providing eaves through to the ridge ventilation. This is a requirement to regulate the amount of condensation in roof voids.

+ Ventilation is dependant on whether a 'cold roof' or 'warm roof' construction method has been used. A warm roof has the insulation at rafter level, while the cold roof has insulation at ceiling level.

+ In accordance with the code of practice that ensures the control of condensation in buildings, both sides of a cold roof must have the equivalent to a 10mm continuous vent at the eaves. If the span exceeds 10 metres, or the pitch is over 35°, ventilation is recommended in the style of a warm roof, which must be at 25mm, with a further 5mm of continuous vent near the ridge.

TRADITIONAL SCOTTISH ROOFING PRACTICE

+ The main stages of the Traditional Scottish Practice are outlined below:

+ The roof should be covered with square edged sarking boards, covered with bitumen underlay or breather membrane, as specified by the architect. (Battens, although not generally specified, can be used to create a warm roof construction).

+ Fixing with two nails is recommended, but it is generally recognised that single head nailing is acceptable where slates are small and heavy. It is also recommended that a proportion of the slates (normally every third course) should be double nailed to resist wind uplift.

+ Fix undereaves courses bed side up.

+ Fix slates to perpend lines, cutting slates to fit hips and valleys.

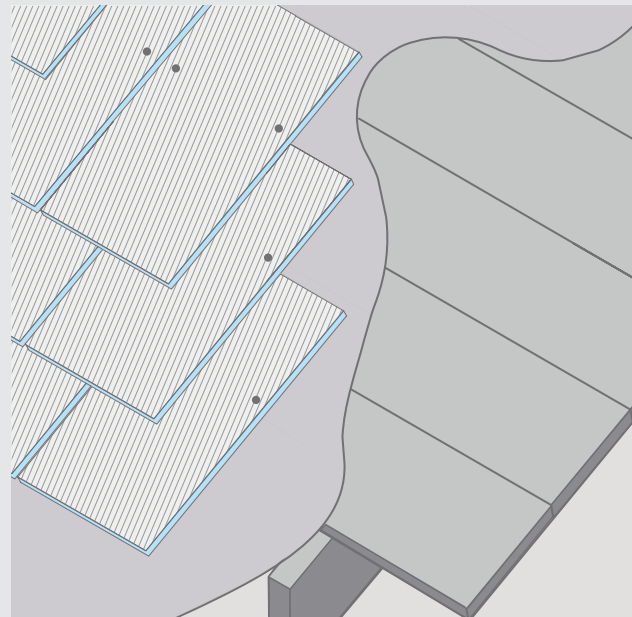

SLATE COVERAGE

This table explains the **required measurements for effective coverage**.

Slate Coverage													
Slate Size	Lap mm												
(Nominal) mm	50	65	75	80	90	100	110	115	120	130	140	150	
600 x 300	12.1	12.5	12.7	12.8	13.1	13.3	13.6	13.7	13.9	14.2	14.5	14.8	
500 x 300	14.8	15.3	15.7	15.9	16.3	16.7	17.1	17.3	17.5	18.0	18.5	19.0	
500 x 250	17.8	18.4	18.8	19.0	19.5	20.0	20.5	20.8	21.0	21.6	22.2		
450 x 300	16.7	17.3	17.8	18.0	18.5	19.0	19.6	19.9	20.2	20.8	21.5		
450 x 250	20.2	20.8	21.3	21.6	22.2	22.9	23.5	23.9	24.2	25.0	25.8		
450 x 230	21.7	22.6	23.2	23.5	24.2	24.8	25.6	26.0	26.3	27.2	28.1		
400 x 300	19.0	19.9	20.5	20.8	21.5	22.2	23.0	23.4	23.8				
400 x 250	22.9	23.9	24.6	25.0	25.8	26.7	27.6	28.1	28.6				
400 x 200	28.6	29.9	30.8	31.3	32.3	33.3	34.5	35.1	35.7				
350 x 300	22.2	23.4	24.2	24.7	25.6	26.7	27.8						
350 x 250	26.7	28.1	29.1	29.6	30.8	32.0	33.3						
350 x 200	33.3	35.1	36.4	37.0	38.5	40.0	41.7						
320 x 220	33.7	35.7	37.1	37.9	39.5	41.3	43.3						
320 x 180	41.2	43.6	45.4	46.3	48.3	50.5	53.0						
300 x 200	40.0	42.6	44.4	45.5	47.6	50.0							
300 x 150	53.3	56.7	59.3	60.6	63.5	66.7							

To calculate the weight per square metre, simply multiply the weight per slate given below by the number of slates per square metre for the same slate listed above.
 For example; 500 x 250mm slate (4-5mm thick) = 1.889 kg x 18.8 (at 75mm lap) = 35.51kg per square metre.

Weight per slate in Kilograms

Slate Size	Thickness		
	(Nominal) mm	4-5mm	6-7mm
600 x 300	2.495	3.899	
500 x 300	2.416	3.290	
500 x 250	1.889	2.760	
460 x 220	1.266	1.848	
400 x 300	1.784	2.690	
400 x 200	1.098	1.809	
350 x 200	0.910	1.675	
300 x 200	0.896	1.138	

The values shown in the Slate Coverage chart above are calculated using nominal sizes and incorporate a 5mm jointing gap. We recommend the addition of at least 5% wastage allowance.

Holing Gauges in mm*

Slate Size	Lap mm														
	(Nominal) mm	50	65	75	80	90	100	110	115	120	130	140	150		
600	340	348	353	355	360	365	370	373	375	380	385	390			
500	290	298	303	305	310	315	320	323	325	330	335	340			
400	240	248	253	255	260	265	270	273	275	280					
350	215	223	228	230	235	240	245	248							
300	190	198	203	205	210	215									

*Measurements should be taken from the tail of the slate.

EAVES

+ A 500mm wide Eaves Protection Strip is fixed to overhang the fascia board and into the gutter.

+ The eaves batten (for the first course of full slates) is the first to be fixed.

+ To ensure the slates hang 50mm into the gutter, the tails of the first course of slates should be offered up to run parallel with the under eaves courses. The under eaves batten is fixed directly below the eaves batten.

+ Head of eave should sit on the first batten underneath the first full course's nail hole and be fixed in position at batten two. Hole position on short slate should be 20-25mm in from cut edge and outer edge.

+ The eaves slates length should be gauge + lap. The first course of full-length slates is fixed over the eave slate to create a double course. The eave slates should be inverted and fixed face down.

+ The under course slates must be head-nailed to the under eaves batten.

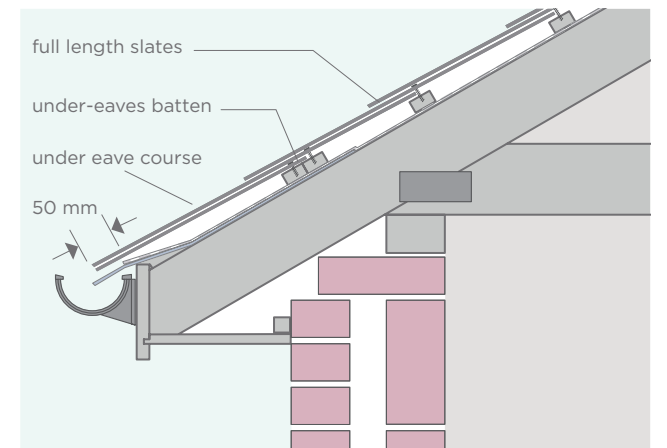
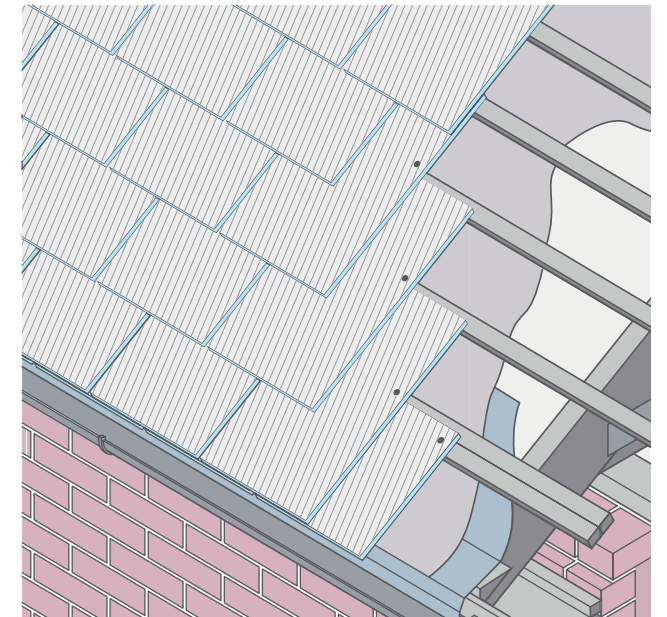



NAIL FIXING ON BARGEBOARD

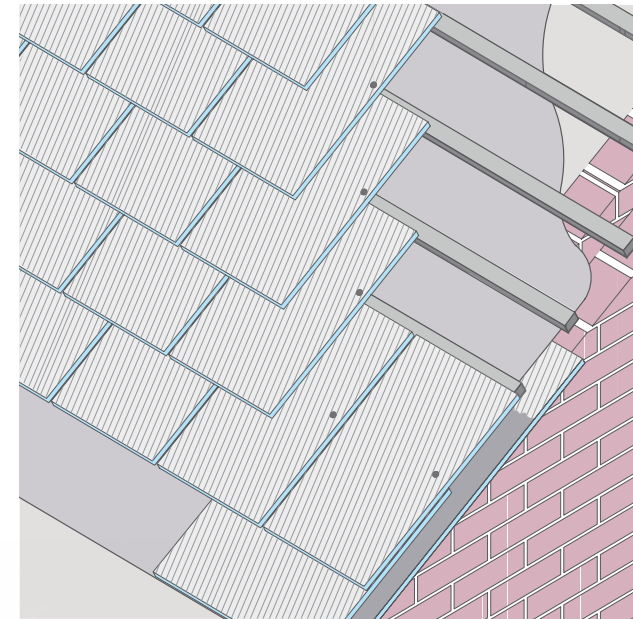

+ Follow the same procedure as for brickwork but in addition, fix the undercloak with nails.

HOOK FIXING

+ One batten should be fixed in parallel to the verge (for brickwork). The verge should be finished in alternate courses of full and half slates (for brickwork). The full slate is then fixed with the hook and one nail, and the half slate with two.

VERGES

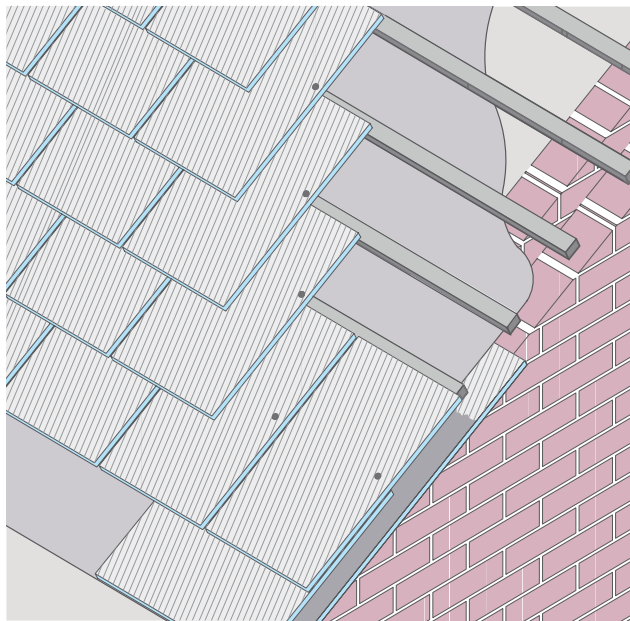

+ Mortar for bedding and pointing; 1:3 cement/sand pigmented to match colour of slates.

+ With a fixed undercloak, slates should be butt jointed and fixed riven side up. It is important that their thickness is not less than 4.5mm. Slate and half should be used in alternate courses with slates. If hook fixing the roof, the slates at the verge should be nailed.

+ On brickwork, the undercloak must be bedded in mortar to provide a 38-50mm overhang. The verge slates should be flush with the undercloak and bedded in mortar. The mortar is then struck off neatly.

+ Battens should be positioned far enough away from inner edge of undercloak so as to give a strong fixing on to it. A gap should be left between the end of the batten and the mortar to avoid moisture ingress to the batten from damp mortar.

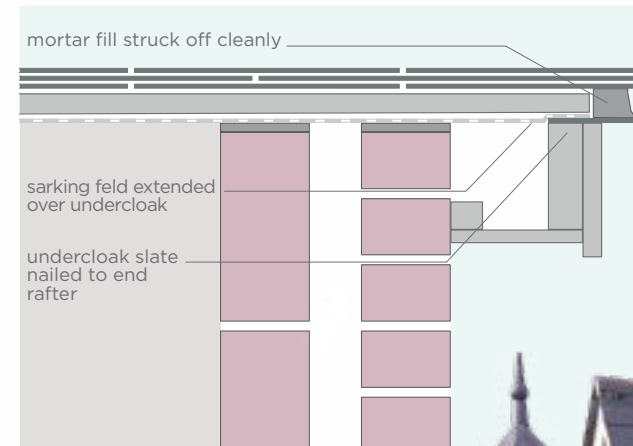
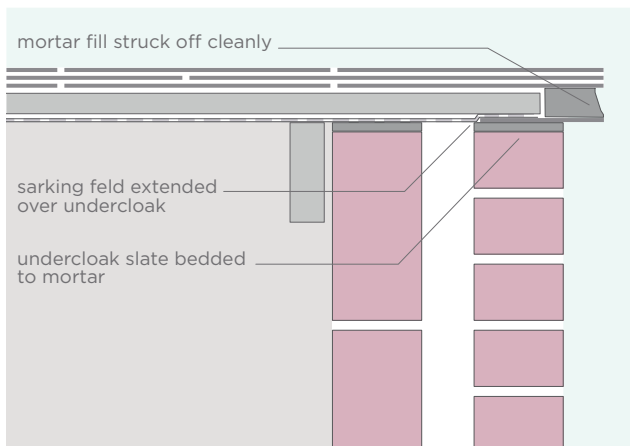



+ Cover the ridge with code 4, 5 or 6 lead depending on the situation. The width of each piece of lead will be the distance round the timber roll plus 150mm on each side covering the slates. On roof pitches below 30° it may be necessary to increase the laps and the cover over the slates to 200mm.

+ Each piece of lead should be fixed to the wood roll at one end with copper or stainless steel nails. The free edge of the lead should be secured with either copper or tern coated steel clips (lead clips are not recommended). The clips should be fixed at each lap and at about 500mm in sheltered exposures. However, in more exposed situations additional restraint may be necessary.

+ The length of each ridge flashing should not exceed 1.5m in length increasing to 2m maximum for code 5 lead.

RIDGES

FOR BOTH TILED OR LEAD ROLL RIDGE

The top slate used should be cut to maintain the lap and be double nailed to the last batten.

Fix a length of underlay over the ridge to overlap the main underlay by no less than 150mm. If the ridges are ventilated, a 50mm gap should be observed. This should run through each pitch along the top underlay. The margin is then maintained by fixing the top course of slates.

When using hooks, one hook and one nail should be used.

TILED RIDGE

Make weathertight by laying ridge tiles to a true line with edges and joints bedded with mortar, struck off as necessary. Separate pointing is not recommended. The ridge ends are filled with mortar and slate slips, finished flush.

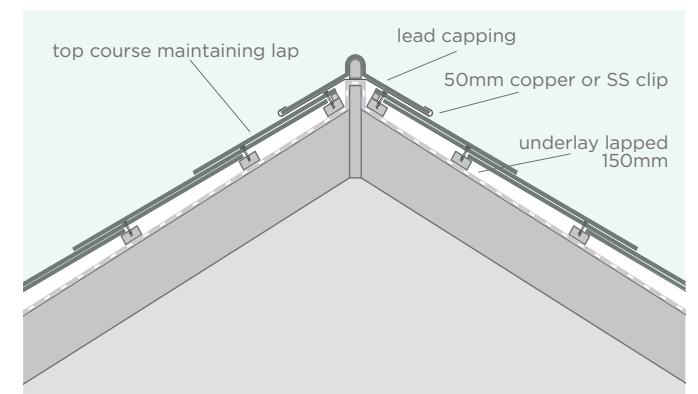
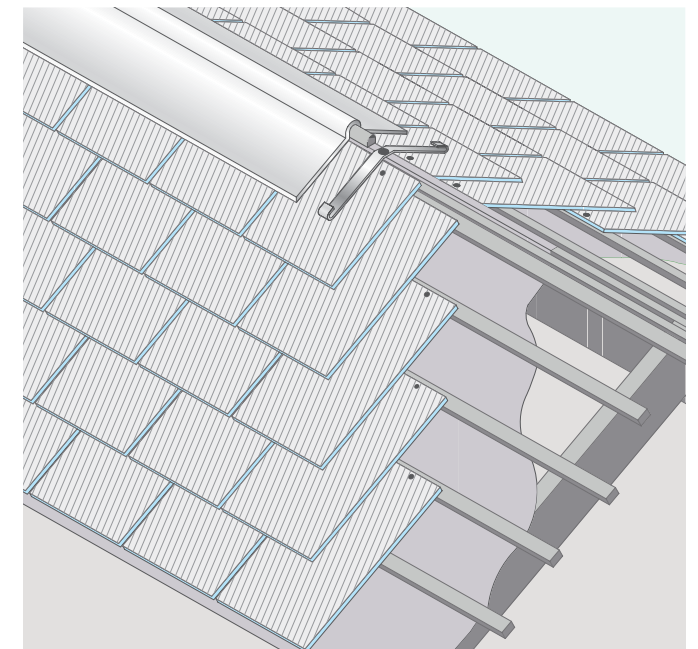
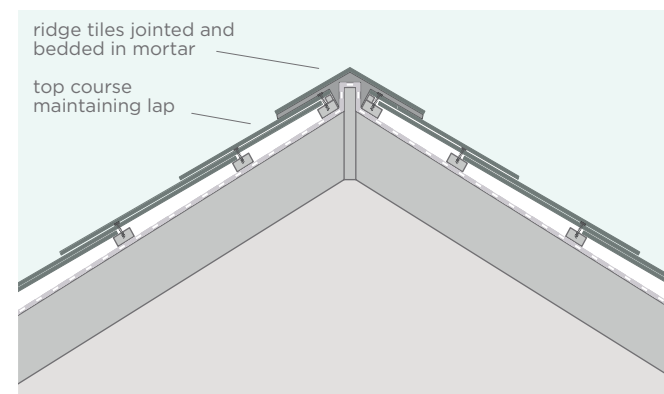
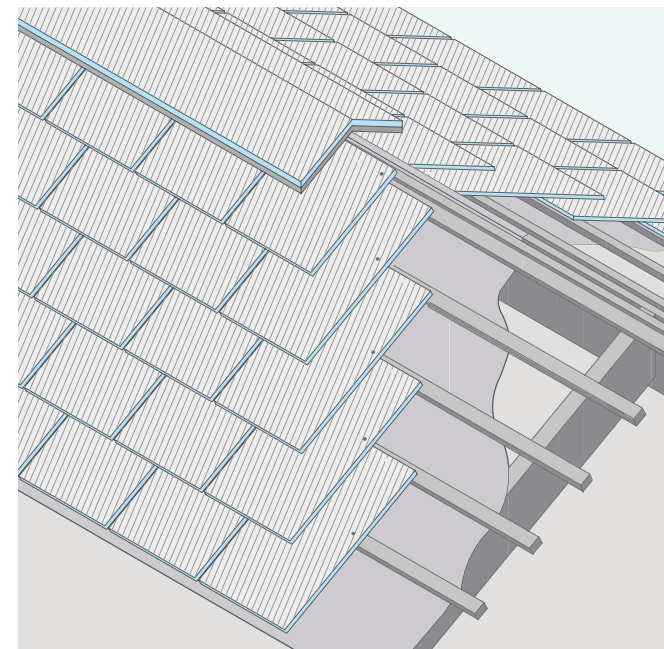

ABUTMENTS

SIDE ABUTMENT

+ It is recommended abutments should be finished using slate and half in alternate courses with a soaker between each course. In the case of a hook fixed roof the slates adjacent to the wall should also be nailed.

+ The soakers should be made of code 3 lead and the length should be gauge + lap + 25mm. Provide a minimum 75mm upstand with the width under the slate to be equal to half the slate width or 100mm whichever is the greater. For hook fixing, the soakers are then fixed with nails into the battens. The soakers should interleave with slates. The soakers should be fixed by bending the top over the head of the slates. It is important to dress down the lead flashing over the soakers as soon as the slating process is accomplished.

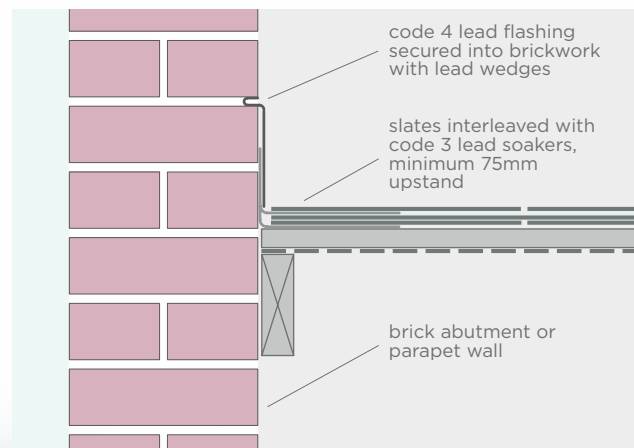
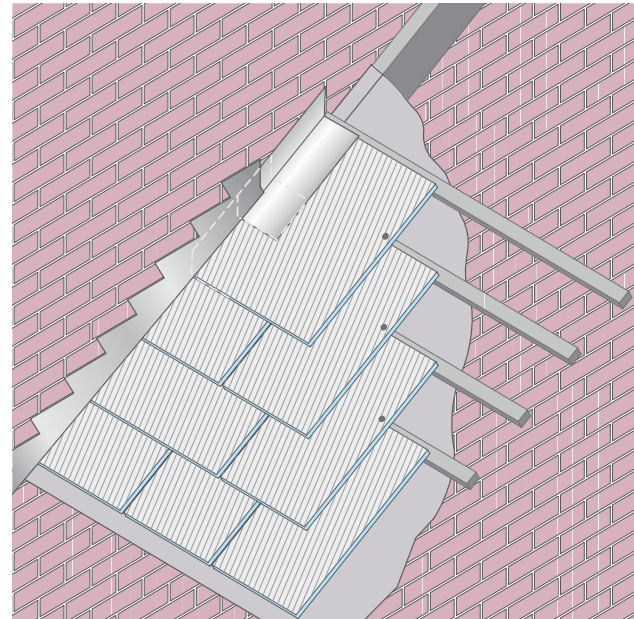

TOP EDGE ABUTMENT

+ Turn the underlay up the abutment by a minimum of 75mm. Maintain the margin with a top course of short slates.

+ Use minimum code 4 lead depending on the situation. Each individual piece should be no longer than 1.5m. The size and laps of the apron flashing is dependent on the pitch of the roof as is the lap. The leading edge of the flashing should be secured with either copper or tern coated steel clips.

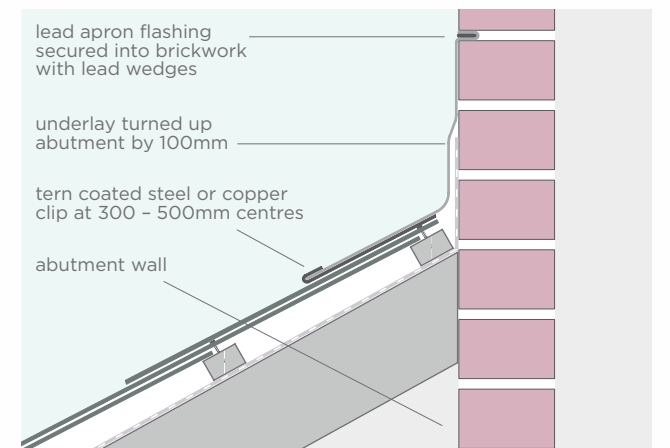
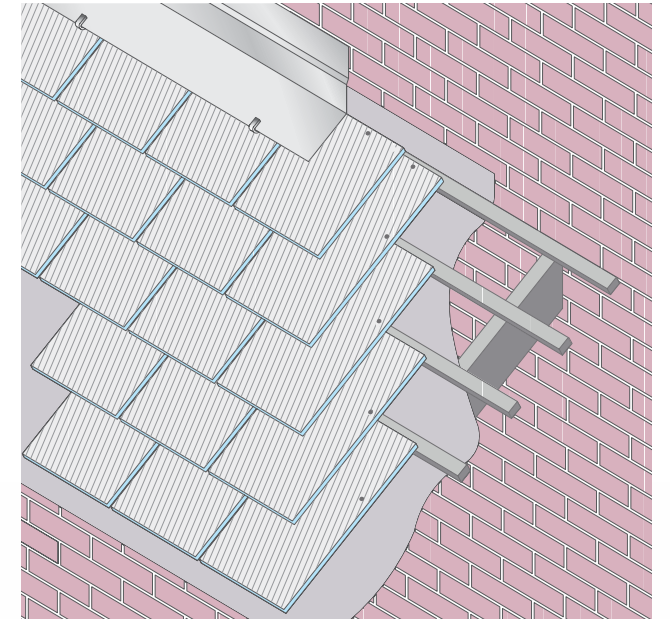

VALLEYS

MITRED VALLEY

Mitred valleys are **not recommended in the following situations.**

- + Below 27.5° roof pitch
- + On valleys longer than 6m
- + In severe rainfall exposure
- + If one roof discharges onto a lower roof.

Lay 600mm wide underlay to underlap the main underlay, then cut the slates accurately from slate and a half for nail fixing, or as required to match the roof for hooks. Form a straight and weathertight mitred junction through interleaving with code 3 lead or stainless steel soakers no less than one slate in length. Soakers should be the width of at least half a slate on both sides of the tail and a slate at the head.

Fix the soakers by nailing to battens at the top edge. When using hooks, the slates that cannot be secured can be left as they are.

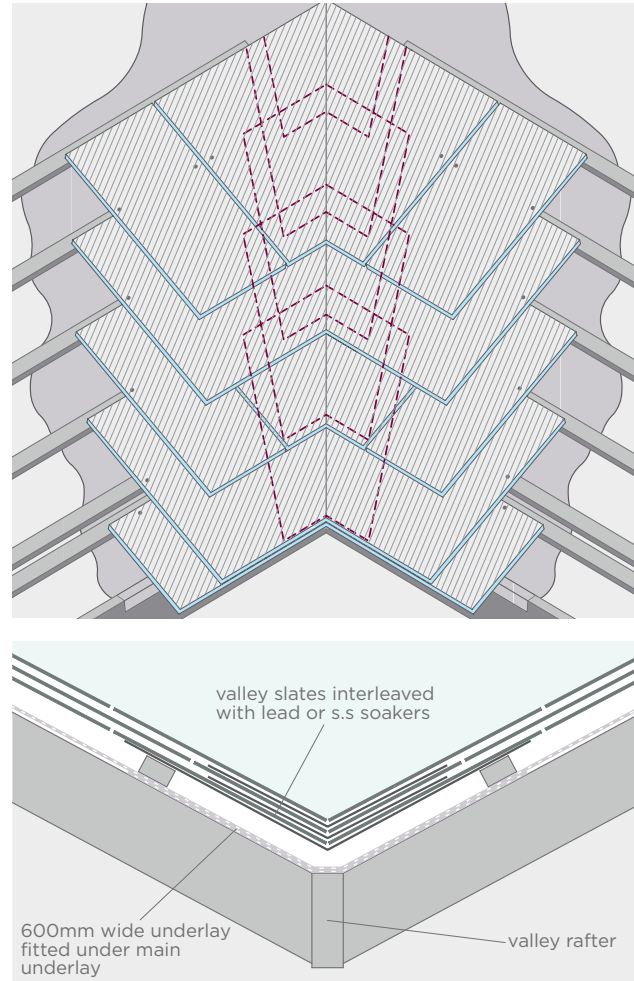

OPEN VALLEY

+ Although the traditional valley gutter width of 125mm has proved to be satisfactory for all normal areas of slating, further tests have shown that the gutter sizes need to be related to the roof pitch, design, rainfall rate and the catchment area. In many cases, a gutter width of 100mm will be adequate.

+ Valley boards must be fixed down the length of the gutter. Fix tilting fillets on either side of the valley board and then the underlay is dressed over this. Dress with code 5 lead strip at least 500mm wide laid in length not to exceed 1.5m, lead dressed over tilting fillets and at least 40mm beyond. A minimum of code 4 lead is used for inclined valleys. Slate and a half might be required to avoid small cuts.

With hook fixing, fix all slates which are adjacent to the valley, with nails.

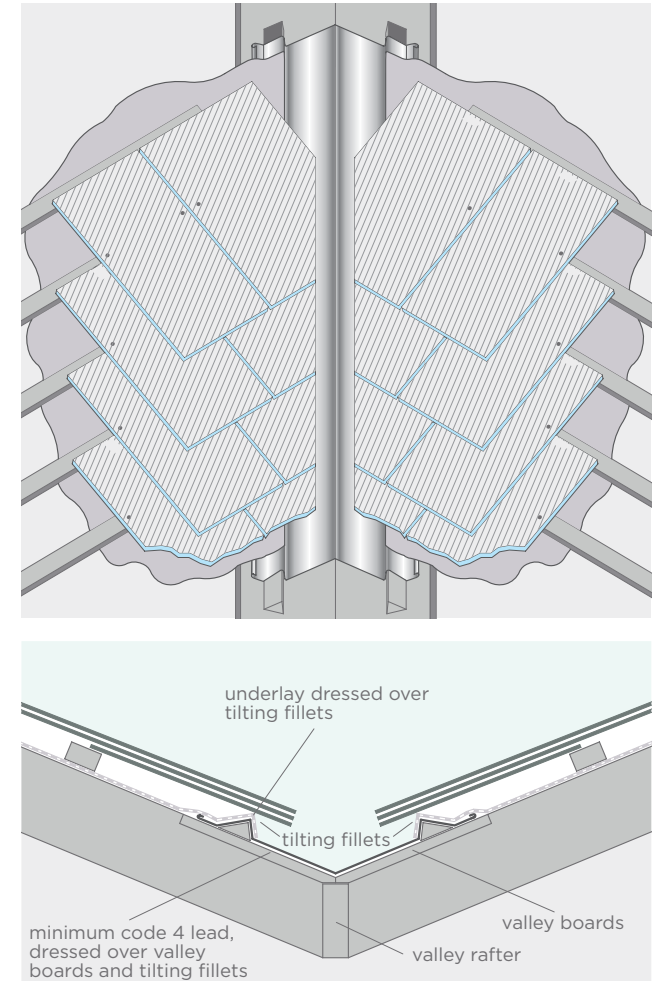

HIPS

The hip can be covered by a wide range of differing hip tiles or a lead roll.

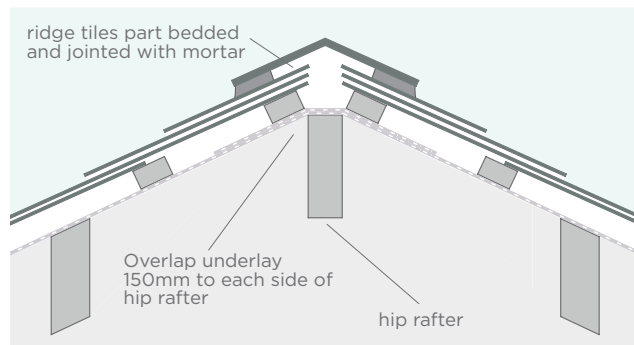
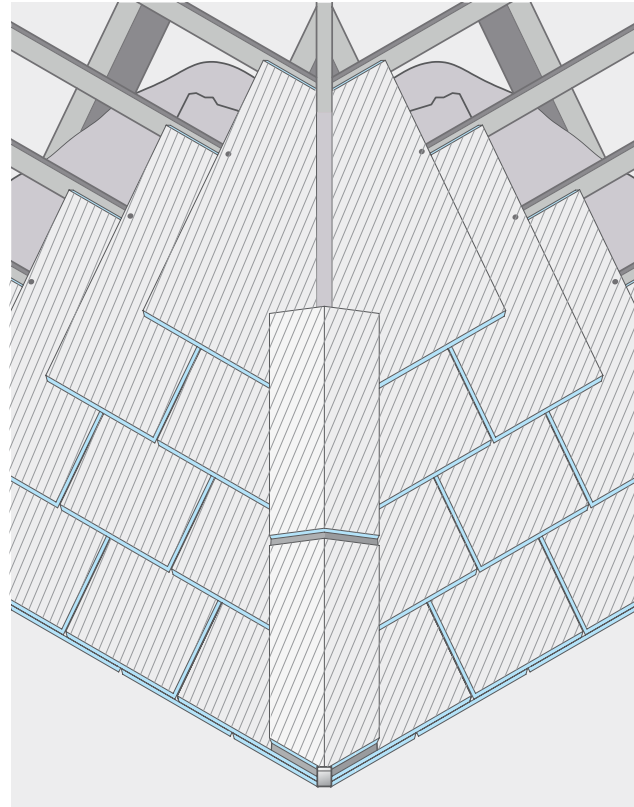

Fixing with ridge **tiled hip**

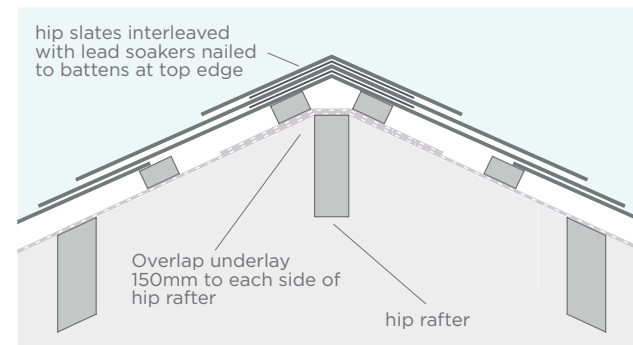
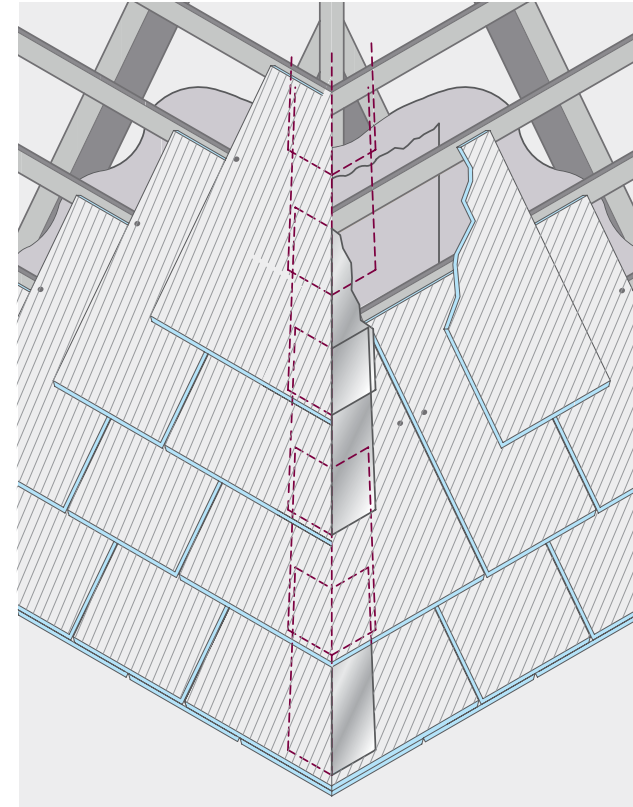

Fixing with ridge **mitred hip**

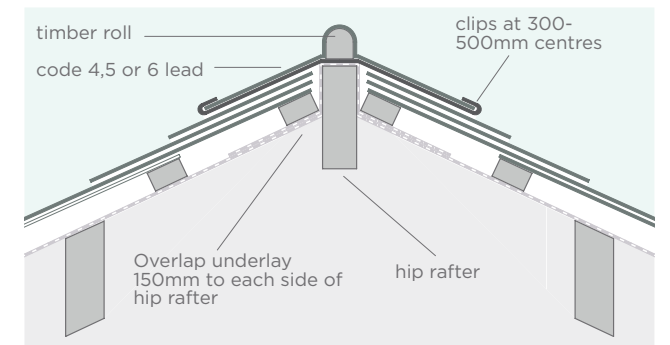
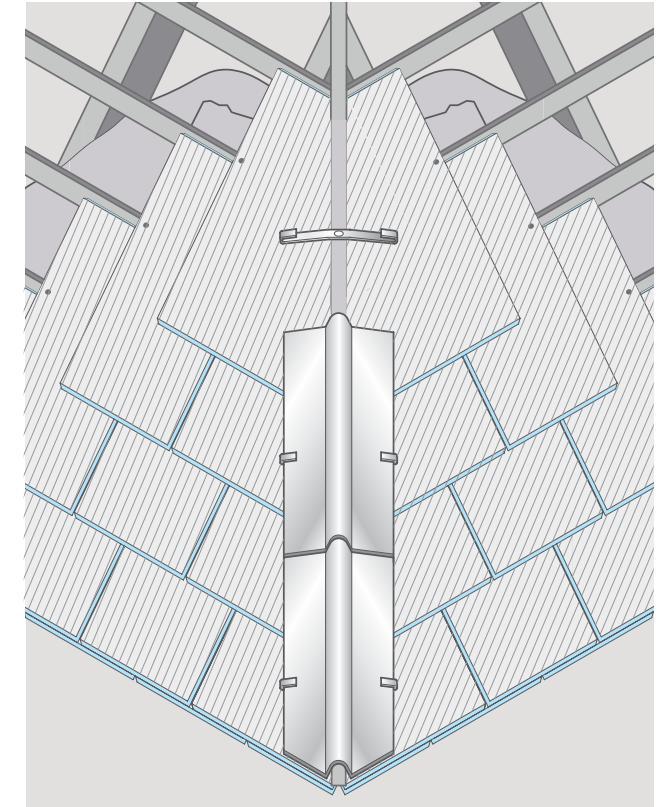

Fixing with ridge **lead rop hip**

RIDGE TILED HIP

- + If mortar is used it should be 1:3 cement/sand pigmented to approved colour.
- + Fix underlay overlapped to a minimum width of 150mm to either side of the hip rafter.
- + Fix a hip iron to the foot of the hip rafter with hot dipped galvanized screws or nails. The slates should be cut as closely as possible to the intersection ensuring the lap and bond are maintained.
- + Hip tiles should be either bedded in mortar or

- ideally mechanically fixed. With a hook fixed roof the slates adjacent to the hip must be nailed.
- + Lay the hip ridge tiles to a true line with edges and joints then bed solidly into the mortar, neatly struck off flush as the work proceeds. The first tile should align with the eaves corner, with the end filled with mortar and slips of slate finished flush.
- + Ridge tiles should be edge bedded and jointed with mortar. If ventilation could become an issue, use a dry ridge or dry vented ridge system.

FIXING WITH MITRED HIP

- + The minimum roof pitch for mitred hips is 30°. Below 35° soakers should extend to 150mm either side of the hip. Seek advice when using mitred hips in areas of severe exposure. Fix underlay as described earlier. Cut slates neatly and accurately, beveled edge down. Interleave with lead soakers to create a close mitred junction. Fix soakers by nailing to battens at the top edge. The slate nearest to the hip slate must be a full slate or a slate and a half to minimise very small cuts, ensure that a raker batten is positioned either side of the hip to allow for mitred hip cuts.

FIXING WITH LEAD ROLL HIP

- + Fix underlay as described earlier. Finish tightly to the timber roll. Cover timber roll with code 4, 5 or 6 lead at width to allow 150mm to be dressed on to the slate beyond the roll. Lay lead in lengths not to exceed 1500mm with joints lapped to suit the roof pitch no less than 150mm. Secure with copper or stainless steel nails and with clips at each lap and at 300-500mm centres. In exposed locations additional clipping will be required.

CHANGES ON ROOF PITCH

Fixing at reduced change of pitch

LOWER SLOPE

Follow the same procedure as the slating for a standard roof top edge abutment.

Fix lay board to the rafters with the top edge in parallel position to the undereaves batten, and at the same thickness as the battens.

Fix a tilting fillet to the lay board.

Ensure the lay board is of sufficient width to allow a welt on the lead above the tilting fillet.

Use a code 5 lead apron flashing fixed over the tilting fillet. This is dressed down over the slate heads below a minimum of 150mm. Lead to be clipped at minimum 500mm centres, however, in exposed locations additional clips will be required.

The upper slope is slated (and battened) as standard eaves, ensuring that the bottom edge of the upper slates overhang the flashing. This should be by 50-60mm.

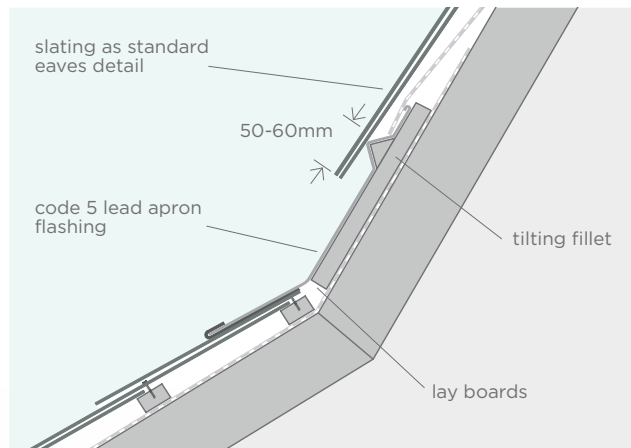
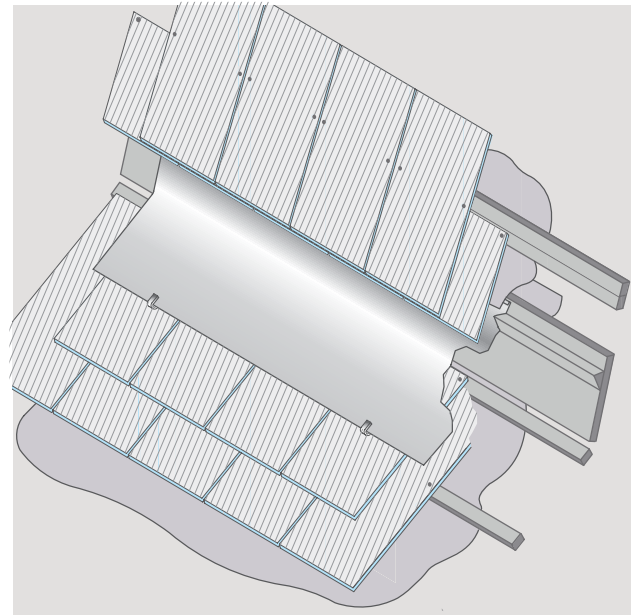

MANSARD JUNCTION

LOWER SLOPE

Follow the same procedure as the slating for a standard roof top edge.

UPPER SLOPE

Fix a tilt fillet, the thickness of the batten, above the junction. Fix a batten immediately above the tilt fillet ensuring it is of sufficient width to allow for a welt on the lead above the fillet.

Use a code 5 lead apron flashing fixed over the tilting fillet. The lead should be of sufficient width to allow a minimum of 150mm apron onto the slating below. Lead to be clipped at minimum 500mm centres, however, in exposed locations additional clips will be required.

The upper slope is battened and slated as standard eaves, ensuring that the bottom edge of the upper slates overhang the flashing. This should be by 50-60mm.

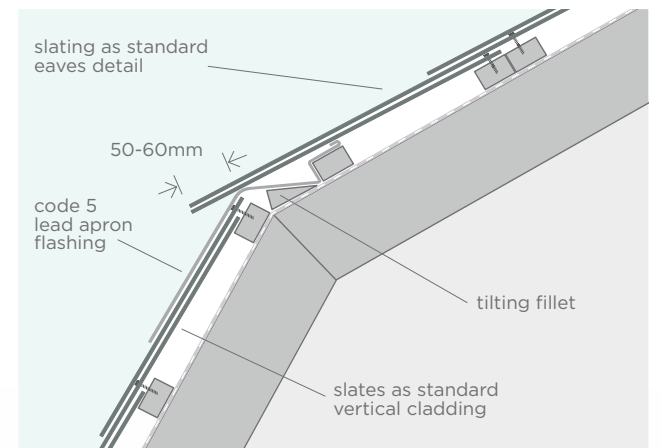
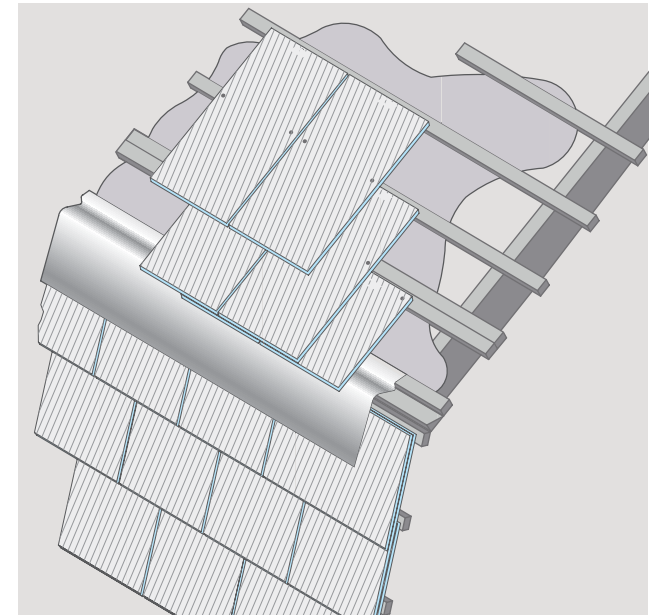

VERTICAL SLATING

This is a method allowing much variety and creativity with design requirements, as well as being economically viable.

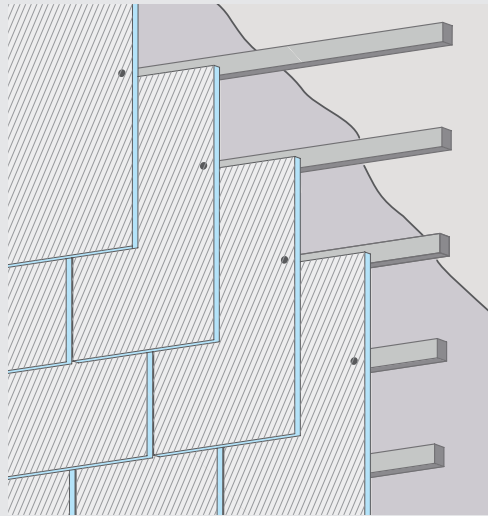

+ Fix either to the batten or to battens and counter batten that have been secured to the wall face.

+ A breather membrane may be required if the substrate is timber framed construction and the slating is acting as a facing.

+ Vertical Slating should be fixed with a minimum headlap of 50mm for nails.



TOP EDGE

Nails: The margin must be maintained by cutting slates for the top course.

Hooks: Top course is finished with lead apron fixed on the hooks.

EAVE

The lower edge is installed in the same manner as roof slating.

ABUTMENT

Use full slate and half width slate on alternate courses near to openings or external edges. If the abutment is adjacent to an opening, additionally interleave with lead soakers and fix with suitable flashings.

Hooks: When encountering external corners or abutments to openings, place soakers at every course in the same manner as verges or mitred verges.

ANGLES

Interleave the cut slates with lead soakers and nail to the top edge of battens. This should be in alternate courses of full slate and half slate.

GABLE ENDS

Splay cut slates under the gable end.



CUP4PIZARRAS

Grosvenor Gardens
52 Grosvenor Gardens
London
SW1W 0AU

uk@cupapizarras.com
Ph. +44 (0) 20 3318 4455



CUPAPIZARRAS.COM